

AUTO TAPE DISPENSER

ZEUT-9GR

INSTRUCTION MANUAL

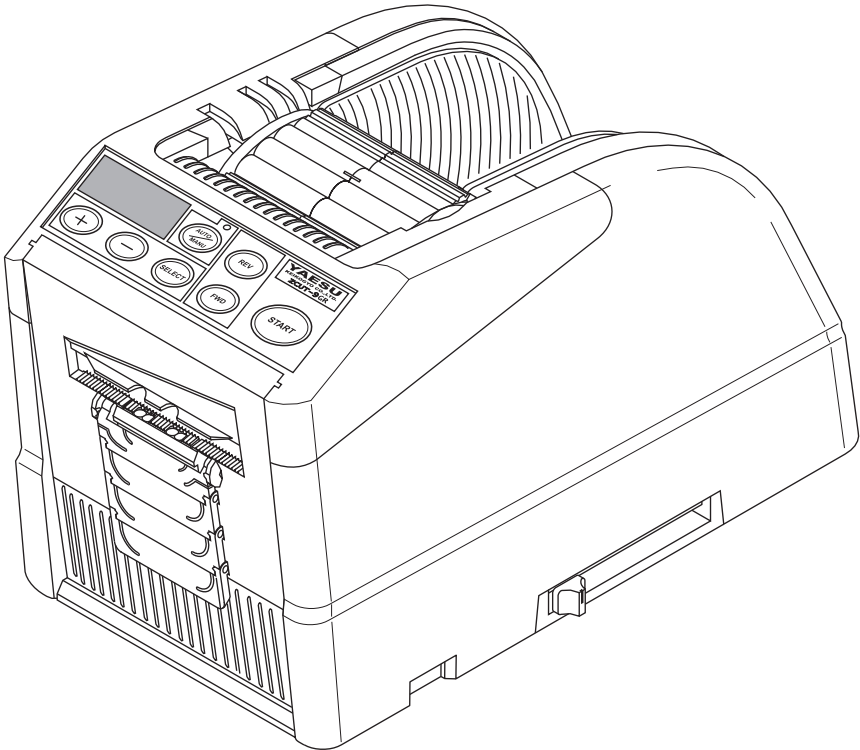

CE

Read Before Use

Thank you very much for buying our tape dispenser ZCUT-9GR. Most of the function is the same as ZCUT-9, but some of additional function such as Removable Roller Unit and Programing Function becomes more convenient.

Please read this Instruction Manual carefully.

For your safety, please always keep this Instruction Manual for reference, retraining and trouble shooting.

Contents

P2	Read Before Use
P3	Safety Instructions
P3	Definition of Warning and Caution Symbols
P4	Warning
P5-6	Identification of Parts
P7	Load the Tape
P8	Set the Tape Length
P8-9	Mode Setting
P10	Programing Function
P11	How to Manage a Curling Tape
P11	Use Narrow Tape / Use Two Rolls in a Same Time
P11	Other Functions
P12	Replace the Blade Unit
P12-13	Maintenance
P13	Error Messages
P14	Roller Unit
P14	Trouble Shooting
P15	Specifications
P16	Warranty

Safety Instructions

The safety guidelines in this Instruction Manual must be observed in order to prevent damage to the machine or injury to the operator or other persons.

The safety guidelines prescribed "Warning " and "Caution" describe possible injury or damage that may be suffered from operating or maintaining the machine in a manner other than as described in this Instruction Manual.

Read and follow the safety precautions carefully before reading the Instruction Manual.

Definition of Warning and Caution Symbols



Warning

Indicates a potentially hazardous situation which if not avoided, could result in death or serious injury.



Caution

Indicate that miss-handling may result in danger and that the operator is at risk of injury, or the machine is at risk of damage.



Indicates Caution

A symbol within the triangle, or the description, will indicate a specific hazard.



A Prohibited Action

A symbol within the circle, or the description, will indicate prohibited action.



A Required Action

A symbol within the circle, or the description, will indicate the required action.

Warning

 Do not plug in, unplug the cord, or operate the machine with wet hands.

Failure to observe this may result in injury due to electric shock.

 Never insert your finger, or any other body part, or any foreign object into the machine.

Failure to observe this may result in injury.

 Keep hair or loose clothing away from the machine while it is operating.

Failure to observe this may result in injury.

 This machine is intended for industrial use only.
Do not allow untrained operators or children to operate the machine.

Failure to observe this may result in injury.

 Turn off the power switch and unplug the machine prior to replacing the blade unit or performing any maintenance on the machine.

Failure to observe this may result in serious injury.

 Do not use this machine for anything other than its specified applications.

Use of the machine for any unintended applications can cause injury to the operator or failure of the machine.

Identification Of Parts

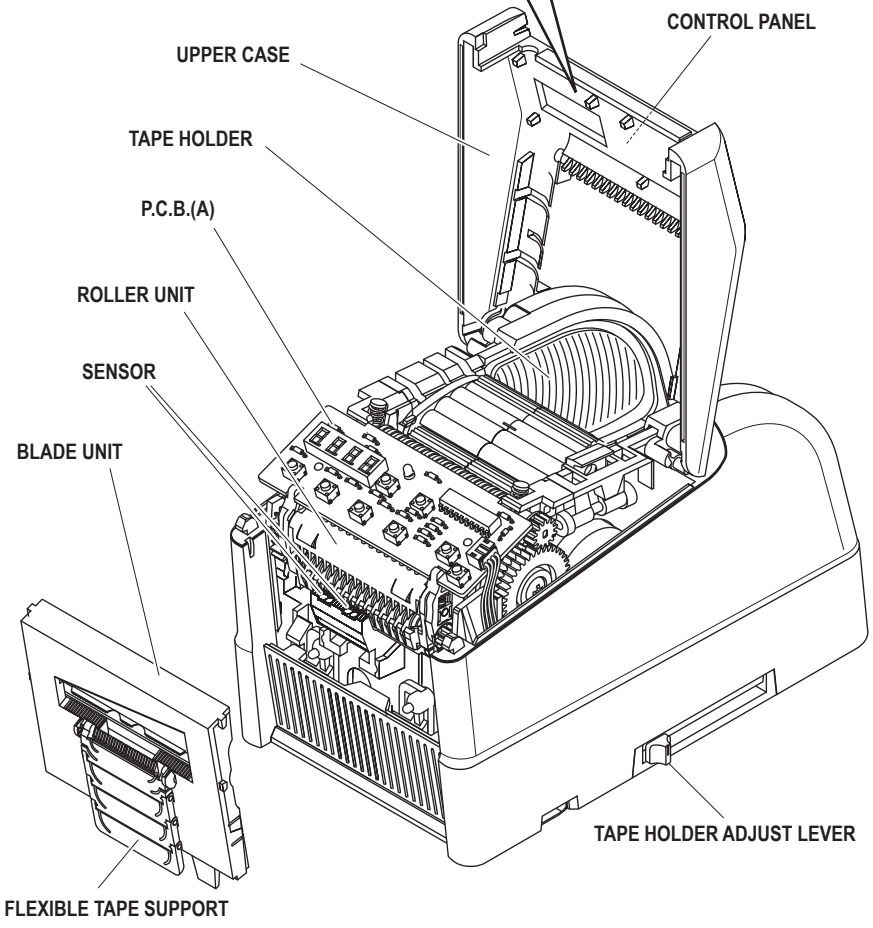
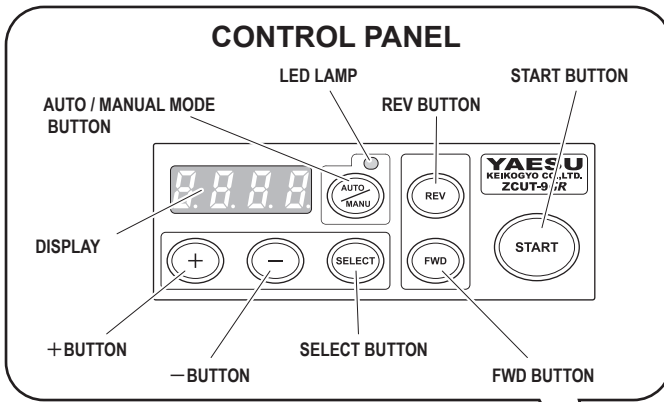

Identification Of Parts

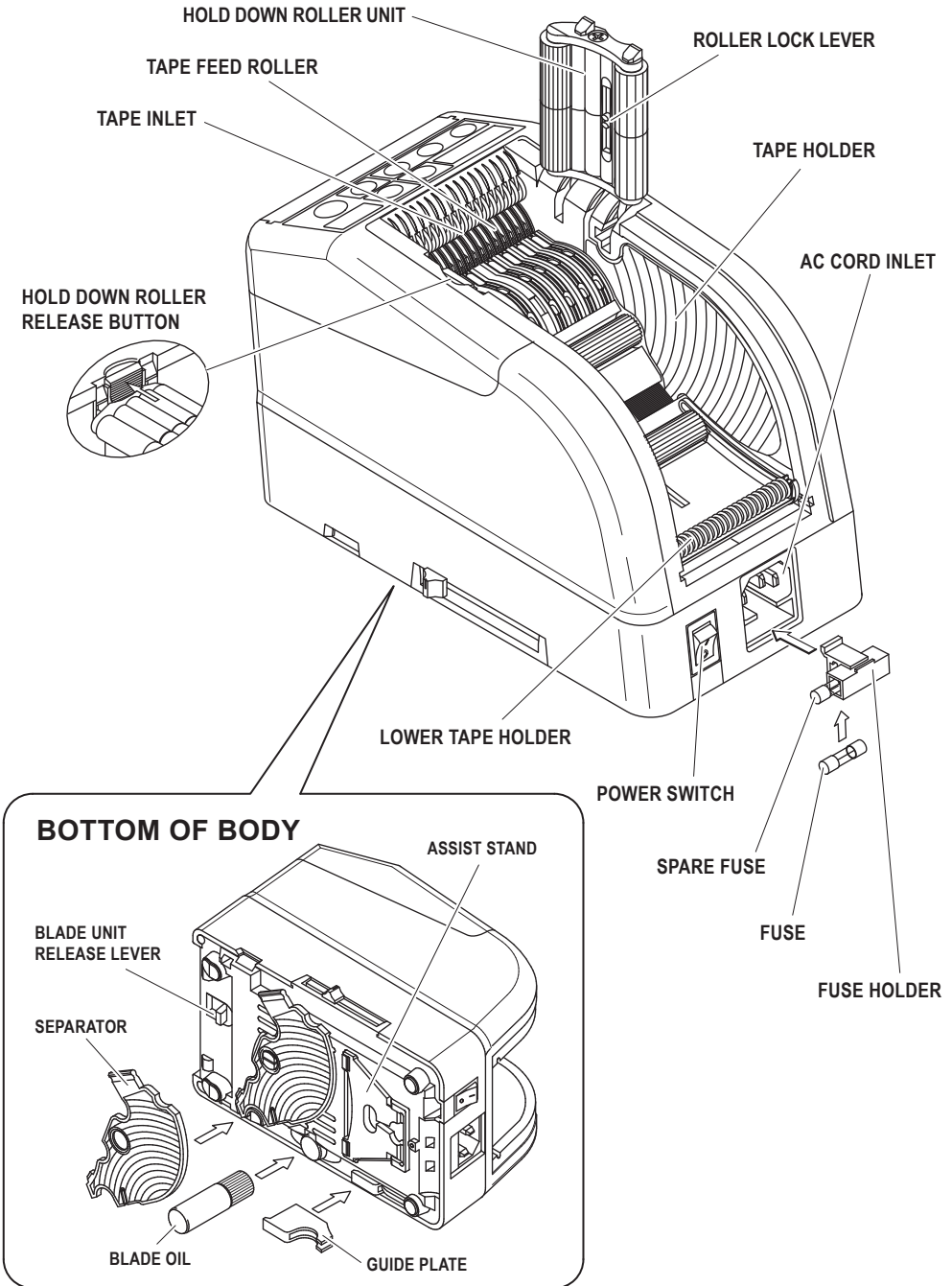

Load the Tape

- ◆ Plug in the AC CORD to the AC CORD INLET.
- ◆ Make sure the POWER SWITCH is off then plug into an appropriate grounded AC outlet.
- ◆ Turn the POWER SWITCH on.
When the POWER SWITCH is turned on, a buzzer will have a sound.
At this moment, the mode is set to MANUAL.
- ◆ Press the HOLD DOWN ROLLER RELEASE BUTTON.
- ◆ Place a roll of tape in the machine.
- ◆ Hold the tape by adjusting the TAPE HOLDERS.

Adjust the TAPE HOLDERS to a proper width, slide the TAPE HOLDER ADJUST LEVER from the front to the rear of the machine then close it.

The TAPE HOLDERS should hold the roll lightly in the center of the cavity of the machine.

This is very important because it keeps the tape in the center.

The tape passes over the SENSOR in front of the BLADE UNIT.

To support a larger roll of tape, pull the LOWER HOLDER out.

- ◆ Put the tape on the TAPE FEED ROLLER.
- ◆ Press the FWD BUTTON until the tape comes out from the TAPE OUTLET.
When using a strong sticky adhesive tape, pull a little bit of tape out in positioning into the TAPE INLET.
Press the FWD BUTTON continuously for a few seconds, also help the tape in positioning in the TAPE INLET.
- ◆ After the tape is loaded and the TAPE HOLDERS are adjusted, close the HOLD DOWN ROLLER UNIT.
- ◆ Press the START BUTTON.
Remove the first piece of tape and discard it.

Now your ZCUT-9GR is ready to use.

! Always use Tweezers to remove tape.

! Whenever set the tape, make sure that adhesive side of tape is always faced down.

- ◆ When you take the roll of tape out from the machine, pull the tape backward and press the REV BUTTON.

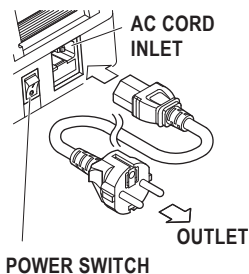

POWER SWITCH

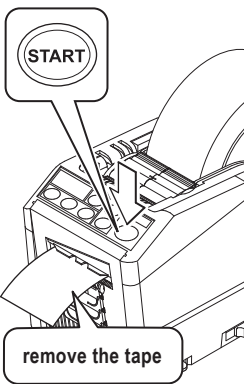
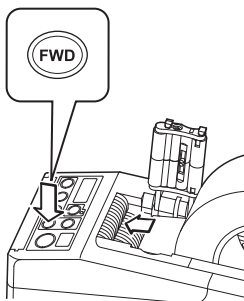
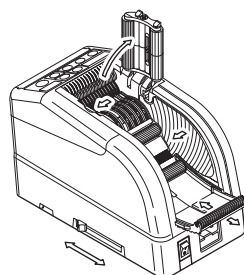

Set the Tape Length

- ◆ Make sure that DISPLAY indicating <cutting length>. The cutting length is always indicates in some alphabets like A,b,C,d,E,F.
- ◆ Set the cutting length. Set your needed length by using +/- BUTTON. The cutting length is adjustable in between 5 mm to 999 mm. Can set six different length by using SELECT BUTTON. If you press +/- BUTTON in a short while, the length in changed to 1 mm. And if you press +/- BUTTON longer, if shows fast forward.

Caution

The actual length is differ from the displayed length depends on the type of the tape and its condition.
 When cutting short length of tape, the length may not cut consistently or tape is jammed.
 Try several test cuts to insure proper operation.
 If pressing —BUTTON for setting from b to F, you will be able to set ZERO. However, machine will not start while alarming even though pressing START BUTTON.

INDICATE CUTTING LENGTH

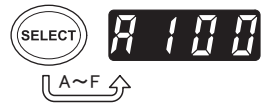

SET THE CUTTING LENGTH

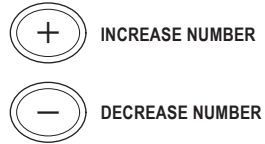

Mode Setting

MANUAL MODE

- ◆ Make sure that blue LED LAMP is off. When the LED LAMP is flashing or turned on, press AUTO/MANUAL MODE and turn off the LED LAMP.
- ◆ Press the START BUTTON once, the machine will feed-in a piece of tape then cut it out based on your set length.
- ◆ To cut another piece, press START BUTTON again.

AUTO MODE

- ◆ Make sure that the LED LAMP is flashing. When the LED LAMP's lights are off, press AUTO/MANUAL BUTTON and let the LED LAMP to flash.
- ◆ Press the START BUTTON once, the machine will feed-in a piece of tape then cut it out based on your set length. When that piece of tape is removed, the machine will feed-in another piece then cut it out. The machine will feed-in and cut a new piece of tape once the piece of tape is removed.

SET AUTO / MANUAL

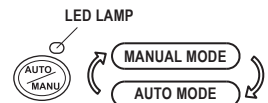

MANUAL MODE

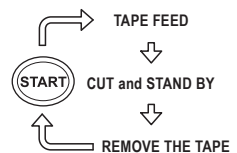

AUTO MODE

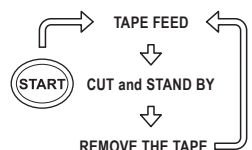

P-MODE (Preset Mode)

The machine is able to be programmed.

A signal will be shown based on your selected quantity of pieces and it will all cut out. (Maximum 999 pieces.)

A buzzer will have sound when the program is finished.

You can use the mode either MANUAL or AUTO.

- ◆ Press SELECT BUTTON to choose your needed length.
- ◆ Press SELECT BUTTON for three seconds then it will indicate "Lcon".
- ◆ Press SELECT BUTTON again then it will indicate "P".
- ◆ Use +/- BUTTON and set your needed number of quantity.
- ◆ Choose AUTO or MANUAL by USING AUTO/MANUAL BUTTON.
- ◆ When you press the START BUTTON, the machine will feed-in and cut out a piece of tape for testing purpose.

To operate the machine by using MANUAL MODE, press the START BUTTON and feed-in a piece of tape after take it out.

To operate the machine by using AUTO MODE, the machine will feed-in a piece of tape automatically.

- ◆ The signal shows numbers backwards when feeding-in another piece of tape.
- ◆ When the DISPLAY indicates "0", the buzzer will have a sound.
The DISPLAY indicates the number of pieces that is preset.
Please wait until the buzzer stops.
If you take the tape out before the buzzer stops, the LED LAMP will flash so you need to press the START SWITCH again.
- ◆ If you try to change the mode (AUTO/MANUAL) when machine is operating, just press AUTO/MANUAL BUTTON.
- ◆ If remaining P MODE and switching off, the number of cutting set will be registered.

L-Mode (Loop Mode)

You can preset the quantity of piece which will be cut out. (Maximum 999 pieces)
The machine will cut out the pieces based on your selected quantities then it will stop.

- ◆ Press the SELECT BUTTON and decide the length of tape.
- ◆ Press and hold SELECT BUTTON so that DISPLAY will indicate "Lcon".
- ◆ Set the number of pieces to be cut out by using +/- BUTTON.
If you want to set the number of cutting in every 100pcs, please press AUTO/MANUAL BUTTON while L con description and increase by 100pcs every time you press. If you want to set the number of cutting in 1-figure or 2 figure, please press +BUTTON or -BUTTON.
- ◆ When you press the START BUTTON, DISPLAY indicates a signal shows numbers backwards and cutting continuously.
When the DISPLAY indicates "0", the buzzer will have sound then the machine is stopped.
To stop the machine while running under L-MODE, press the START BUTTON.

Caution

The number of cutting set will remain registered even if switching off while L MODE. However, it will be eliminated if pressing SELECT BUTTON longer for setting.

P-MODE

INDICATE CUTTING LENGTH

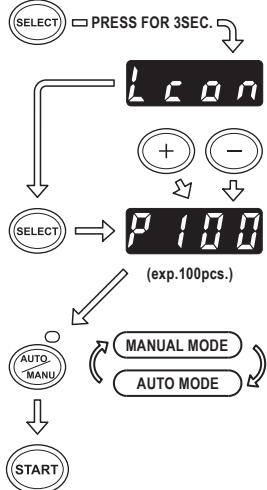

L-MODE

INDICATE CUTTING LENGTH

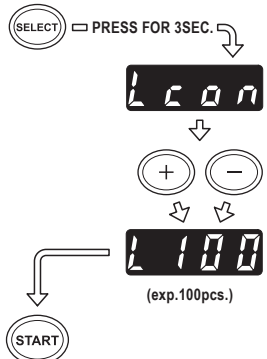

Programing Function

Function that cuts the material registered from A to F accordingly.
As refer to the following figure, operation will keep working.
This function may apply every mode.

- ◆ Please follow the instruction on page 7.
- ◆ Set the cutting length from A to F as you prefer.
- ◆ Please set the cutting length in ZERO for between B to F if not necessary. Then skip the position registered with ZERO accordingly and operate repeatedly.
- ◆ Apply the cutting length to your first cutting.
- ◆ Press AUTO/MANUAL BUTTON more than 1 second. Then [.] will appear on the lower right of Alphabet.
- ◆ Press AUTO/MANUAL button and select AUTO MODE or MANUAL MODE.
- ◆ Press START BUTTON and tape is ready to take. When setting MANUAL MODE, the next cutting length will be displayed. When setting AUTO MODE, the next cutting tape is ready to take with displaying the cutting length.
- ◆ When discontinuing Program Function, please press AUTO/MANUAL BUTTON longer and make sure that [.] is eliminated.

operating example

- ⇒ in the case of 6 different cut length setting
- in the case of zero setting for E. F.

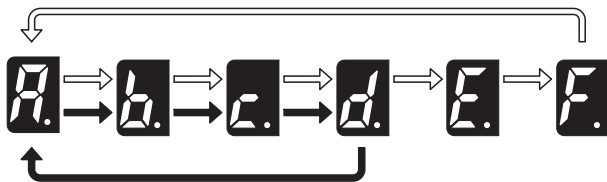

- ◆ Please take the following procedure when using P MODE or L MODE. After setting Programing Function, press SELECT BUTTON and P will be displayed. Set the number of cutting and press START BUTTON. Material will be cut until the number reaches ZERO.
- ◆ After setting P MODE or L MODE, press AUTO/MANUAL BUTTON if you want to have Programing Function.

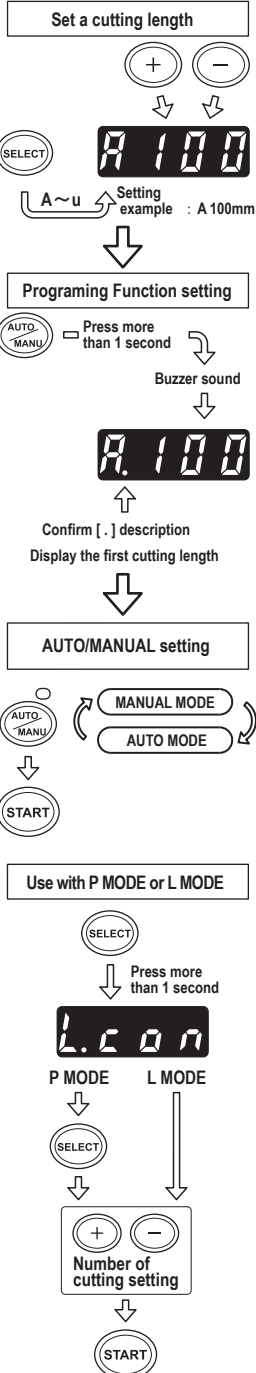

How to Manage a Curling Tape

◆ Press the HOLD DOWN ROLLER RELEASE BUTTON in order to open the HOLD DOWN ROLLER UNIT.

◆ Extend the ROLLER LOCK LEVER so that the roller will not turn.

◆ Close the HOLD DOWN ROLLER UNIT.

With the rollers locked, the tension may cause the length to vary.

Cut several test pieces in order to adjust the length if needed..

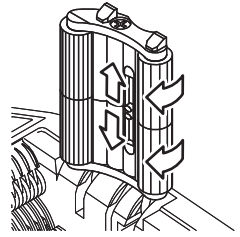

Use Narrow Tape / Use Two Rolls in a Same Time

If the tape is lesser than 25 mm width or you want to dispense two rolls in a same time, use the SEPARATOR.

Cut lesser than 10 mm width of tape, put the GUIDE PLATE on the SEPARATOR.

◆ Remove the SEPARATOR from the bottom of body.

◆ Open the HOLD DOWN ROLLER UNIT.

◆ Insert the SEPARATOR into the body by slotting in to the bottom of the cavity.

◆ When you cut the tape lesser than 10 mm, put the GUIDE PLATE onto the Separator.

◆ Place one roll of the tape on either side by inserting a SEPARATOR for loading tape.

◆ To hold the tape by adjusting TAPE HOLDERS, it is unnecessary to push the SEPARATOR out of position.

When dispensing two roll of tapes in a same time, it is a must to feed-in both of its' length in a same time.

◆ Remove the first piece of tape.

◆ When the second piece of the tape is removed, both side of tapes are also dispensed.

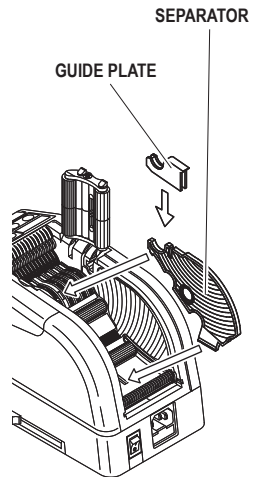

Other Functions

FLEXIBLE TAPE SUPPORT

When you cut the tape longer or cut non-adhesive tape / film, use FLEXIBLE TAPE SUPPORT in order to avoid the tape fall down.

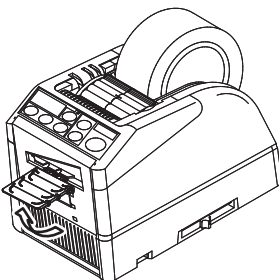

ASSIST STAND

Based on the tape material or workpiece purpose, use the ASSIST STAND in order to let the body of machine towards a lower level.

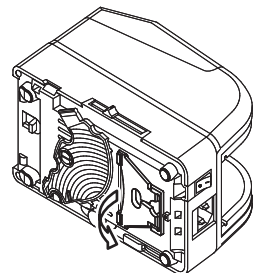

Replace the Blade Unit

Only Blade is not accepted to be replaced.
It needs to change with the whole Blade Unit.

- ◆ Turn the POWER SWITCH off.
- ◆ Remove the BLADE UNIT by releasing the BLADE UNIT RELEASE LEVER.
- ◆ Install the new BLADE UNIT into the body.
- ◆ Push down on the housing firmly until it is locked.

Make sure that the lower blade is positioned properly, turn the BLADE UNIT over and take a look the bottom edge of the lower blade.

Maintenance



Whenever you clean or replace the BLADE UNIT, do not touch the sharp edge of the blade.

Clean the Blade Unit

When cutting tapes with heavy adhesive, the residue will remain on the blade gradually.

It is necessary to remove the BLADE UNIT for cleaning.

- ◆ Turn the POWER SWITCH off.
- ◆ Remove the BLADE UNIT by releasing BLADE UNIT RELEASE LEVER.
- ◆ Put some alcohol on a clean dry cloth, or use a swab to remove the residue.
- ◆ Replace the BLADE UNIT.

Lubricate the Blade

Lubricate the blade in order to prevent residue stick on the blade.

- ◆ Turn the POWER SWITCH off.
- ◆ Remove the BLADE UNIT from the body.
- ◆ Locate three oil holes on the back side of the top blade.
- ◆ Drip one drop of BLADE OIL into each hole.
- ◆ Also lubricate LOWER BLADE GUIDE.
- ◆ Do not lubricate over and over again.

Wipe the spare oil away by using cotton cloth.

- ◆ Replace the BLADE UNIT into the body.
- ◆ Turn the POWER SWITCH on.

Make several test cuts in order to make sure the tape will not fall down from the TAPE OUTLET.

Clean the Sensors

There are two pairs of SENSORS below the TAPE OUTLET.

If the opening is covered by tape residue or debris, the SENSORS will not detect the presence tape.

Always keep clean around the SENSORS.

To protect the SENSOR, clean the openings after removed the BLADE UNIT carefully.

REMOVE BLADE UNIT

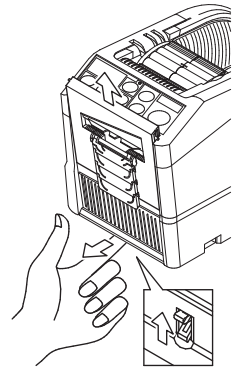

INSTALL BLADE UNIT

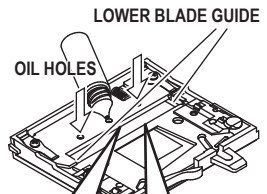
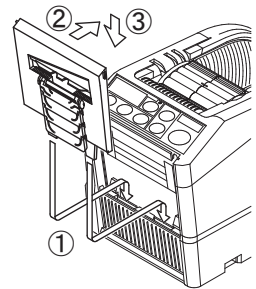

EXTREME CARE
OF BLADE

BE CAREFUL TO HANDLE
THE SENSORS

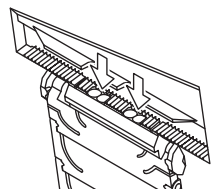

Roller Unit

When waste of tape glue is found, please refer to page 14 and follow the procedure for cleaning ROLLER UNIT.

Clean the Body

Put neutral detergent on a damp cloth to clean the body.
Do not use alcohol or solvent to clean the plastic parts.

Error Messages

The buzzer will has a sound then a message will flash and show on the DISPLAY.

E-02 Blade is Out of Position

A signal shows that the blade is not installed well or machine stops because of the thickness or hardness of the tape.

- ◆ Turn the POWER SWITCH off.
- ◆ Remove the BLADE UNIT by releasing the BLADE UNIT RELEASING LEVER then lift the assembly out of the body.
- ◆ Turn the POWER SWITCH on.
- ◆ Press the FWD BUTTON and feed -in the tape once, cut the tape in between the TAPE OUTLET and the BLADE UNIT by scissor.
- ◆ Press the REV BUTTON to remove the tape.
- ◆ Clean the BLADE UNIT and lubricate the LOWER BLADE GUIDE.
- ◆ Check the lower blade position and replace the BLADE UNIT.

E-03 Motor is Stopped

Indicates that the motor is stopped because of overload.

- ◆ Press the START BUTTON to clear the error message.
- ◆ Press the REV BUTTON to remove the tape.
- ◆ Turn the POWER SWITCH off.
- ◆ Check the BLADE UNIT and TAPE OUTLET carefully.
- ◆ Clear and take away the spare tape waste or sticky residue by using tweezers.(Clean ROLLER UNIT as depends on the condition.)

POWER SWITCH IS OFF



REMOVE BLADE UNIT



POWER SWITCH IS ON



CLEAR THE ERROR



FEED THE TAPE



REMOVE THE TAPE



CLEAR THE BLADE



SET THE TAPE



CLEAR THE ERROR



REMOVE THE TAPE



SET THE TAPE



Do not touch the Blade when you are correcting an error under POWER SWITCH is on.



Turn off the POWER SWITCH and stop using the machine.
If the machine cannot work normally after correcting the error.
It seems that nothing wrong without any error messages.



Do not use the tape if static electricity generates over 1000V.
It may cause failure to the machine.

ROLLER UNIT

When tape jammed, you can remove ROLLER UNIT without using any tools and make sure about the status of Roller Unit.

Machine can be stable due to easy cleaning and removal of tape waste.

◆ Please switch off and remove power cord from machine.

◆ Remove BLADE UNIT.

◆ Please take the following procedure.

- ① Pull UPPER CASE of Front Panel forward -2mm.
- ② Lift UPPER CASE up while pulling and open it.
- ③ Remove P.C.B (A) .
- ④-⑤ Push and release HOLD DOWN ROLLER UNIT.
- ⑥ Apparently lift ROLLER UNIT up.

◆ When removing FRONT ROLLER, please take the following procedure.

- ⑦ Pull the PROJECTION on ROLLER UNIT from side to side.
- ⑧ Lift up and open TAPE GUIDE PLATE.
- ⑨ Remove FRONT ROLLER.

◆ ⑩ If pulling SENSOR down forward and follow the instruction as mentioned above, FRONT ROLLER can be removable without removing ROLLER UNIT.

◆ When assembling, please take the procedure conversely as you do.

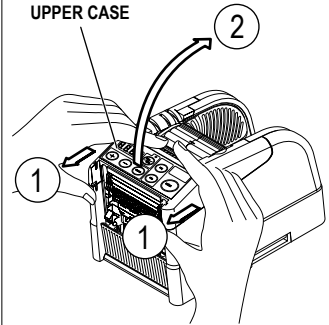

HOLD DOWN ROLLER RELEASE BUTTON

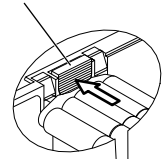

Notice

★ When removing Roller Unit, please be careful not to lose any of gears due to dropping.

★ When assembling, please assemble the right parts to the right position.

★ Please do not put P.C.B. cord between any of parts.

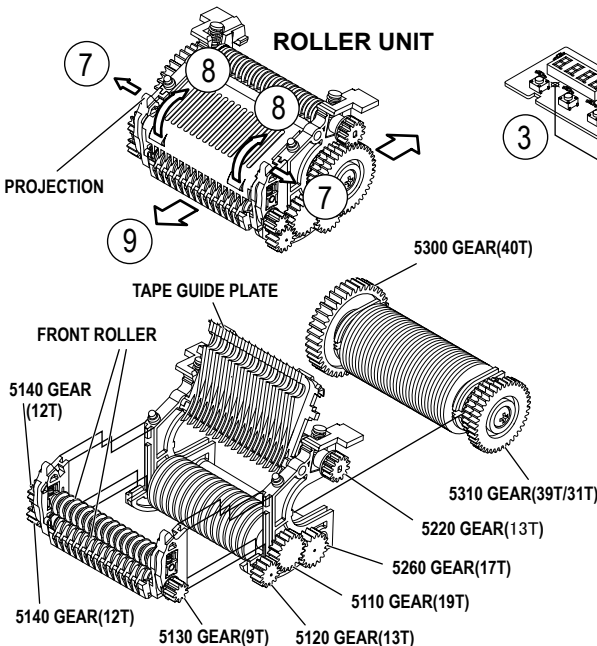
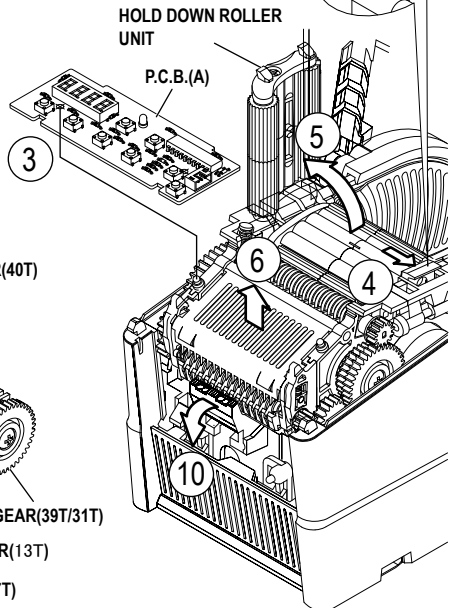

Trouble Shooting

Before returning the machine for repairing, please check the followings.

The POWER SWITCH is on but the machine can not run.	The AC CORD is loosen. The FUSE has been blown.	Check the AC CORD then plug in the outlet firmly. Replace the FUSE. Stop using the machine immediately even though the FUSE is blown again after replace.
After removing piece of tape, the next piece does not feed under AUTO mode.	The mode is set MANUAL. Some debris are covering on the SENSORS. The tape can not goes through the SENSORS. The tape has extremely low reflectance.	Set the mode to AUTO. Remove the debris. Use SEPARATOR to narrow the tape lesser than 25mm, Do not bring strong illuminant close around the SENSORS. Some types of tape may not be used under AUTO mode.
The BLADE can not move smoothly.	The BLADE UNIT is not in a proper position.	Check the BLADE UNIT and push down on the housing firmly.
The length of the tape is different from the set length.	The adhesive of tape is too strong. The elasticity of tape is too strong.	Correct the setting after cutting several test pieces.
Tape curls excessively.	The machine is not grounded. The ROLLER LOCK is disengaged.	Check ground on cord. Engage the ROLLER LOCK to apply tension.



If the machine still can not operate properly, stop using the machine immediately and contact vendor for repair authorization.

Specifications

Power Requirement	100-240VAC 50/60Hz
Input Voltage Range	±5%
Wattage	25W
Dimensions	116mm(W) x 140mm(H) x 213mm(D)
Weight	1.6 KG.
Body Material	ABS
Tape Length	5mm ~ 999mm
Tape Width	6mm ~ 60mm
Feeding Speed	220mm/sec. (using Craft Tape)
Max. Outside Dia. of Roll	300 mm
Accessories	Power Cord 2A Fuse [Built-In Inlet] Separator / Guide Plate / Blade Oil

Remarks ◆The specifications are subject to change without prior notice.

◆The length of the tape may differ from the set length depending upon the type of the tape or its condition.

◆Some types of tape available with the machine may not be cut depending upon conditions.

Warranty

We warrant to the original purchaser of the product that will be free from defects in material or workmanship for as long as the original purchaser owns the product, when given normal wear and proper usage.

The limited warranty for the machine shall be for a period of 180 days from the date of purchase.

The spare parts such as Cutting Blades, Rollers, are not covered under the warranty period as they are considered as "wear parts".

This warranty is only valid if the product:

- ◆ Was not damaged while being installed.
 - ◆ Was operated in accordance with products's specifications, instructions and any technical support directions.
 - ◆ Was not modified or damaged by tempering, user error, accident, disaster, abuse, misuse, power supply, power application, alternation, repair, modification, a fix or replacement by someone other than the original product.
-