

REV.	ECN NO.	DATE	SIGN	DESCRIPTION
B	LEN14B0095	2014/11/04	Vicky	Update Logo

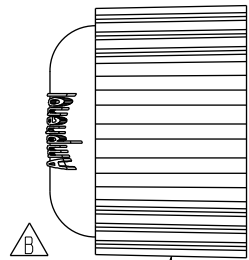

Sealing Nut (5)

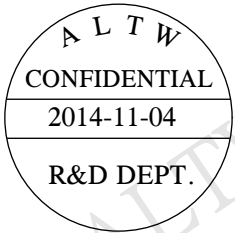
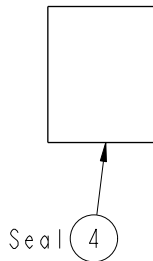

Seal (4)

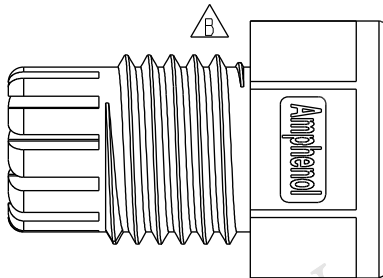

Clamp Ring (3)



Gasket (2)

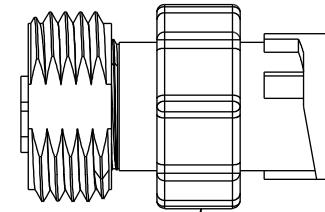

Connector (1)

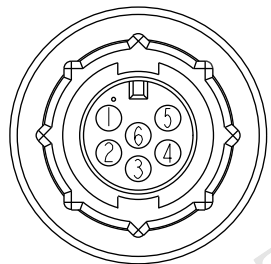

Pin Assignments Front View

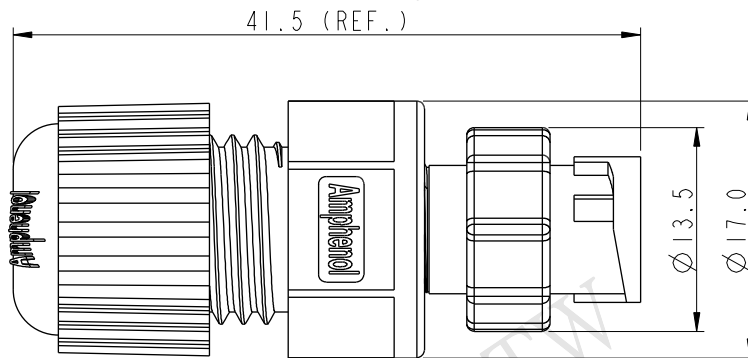

Note:

- * Waterproof Rate: IP67
- * Housing: Nylon+GF, Black
- * Male Pin: Copper Alloy, Gold Plated
- * Gasket: EPDM, Black
- * Clamp Ring: Nylon, Black
- * Seal: EPDM, Black
- * Sealing Nut: Nylon, Black
- * Seal For Cable OD: $\varnothing 4.5\text{mm} \sim \varnothing 6.5\text{mm}$
(防水墊圈線徑: $\varnothing 4.5\text{mm} \sim \varnothing 6.5\text{mm}$)
- * One Set Unassembled In One PE Bag
(每一組未組裝, 放置於一個PE袋, 並封口)

UNIT:mm		
TOLERANCE	.X ± 0.25	.XX ± 0.1
	.XXX ± 0.05	ANGLES $\pm 1^\circ$

TITLE MINI SIZE CURRENT 2A			
SCALE 2:1	SIZE A4	SHEET 1 OF 1	
REV. B	WC-REV. A.2	QC: Inspection item	

Amphenol LTW
安費諾亮泰企業股份有限公司

ITEM NO AU-06BMMMA-LL7001	DRAWN BY Vicky	DATE 2014-11-04
DWG NO AU-06BMMMA-LL7001	CHECKED BY Sam	DATE 2014-11-04
CUSTOMER ALTW	APPROVED BY Rita	DATE 2014-11-04

THIS DOCUMENT IS SUBJECT TO CHANGE WITHOUT NOTICE. IT IS CONFIDENTIAL AND A PROPERTY OF Amphenol LTW. DISCLOSURE TO THIRD PARTY HAS TO BE AUTHORIZED BY Amphenol LTW.

Mouser Electronics

Authorized Distributor

Click to View Pricing, Inventory, Delivery & Lifecycle Information:

[Amphenol:](#)

[AU-06BMMA-LL7001](#)