

產品成品圖

(Product drawing)

(3.0mm Pitch Series)
(Housing)

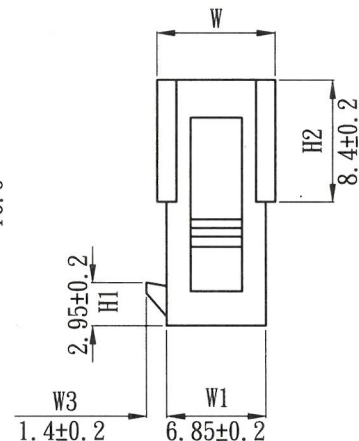
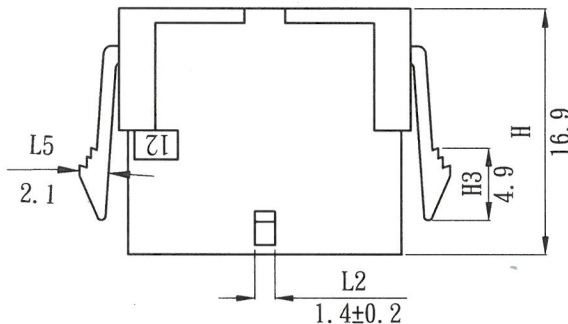
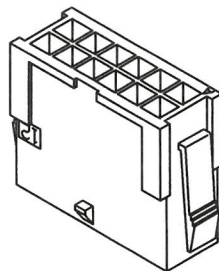
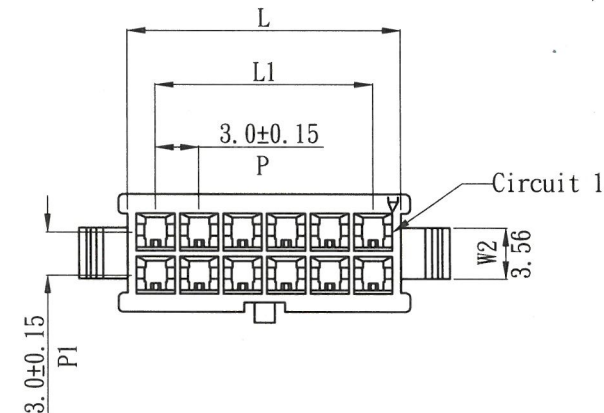

PD4~PD24

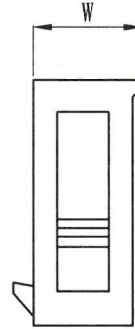

PD2

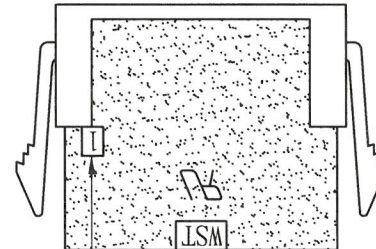
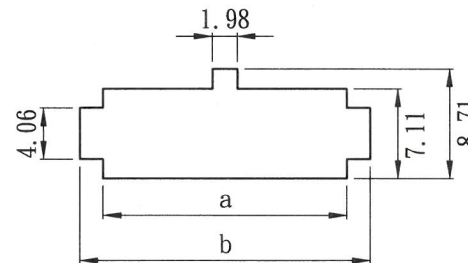

Circuit 1 Mark

Part NO.	Dimension					Q' ty/bag
	L	L1	W	a	b	
PD2-I30001	3.85		7.50	4.21	7.90	1000 PCS
PD4-I30001	6.85	3.00	8.15	7.21	10.90	1000 PCS
PD6-I30001	9.85	6.00	8.15	10.21	13.89	1000 PCS
PD8-I30001	12.85	9.00	8.15	13.21	16.89	1000 PCS
PD10-I30001	15.85	12.00	8.15	16.21	19.89	1000 PCS
PD12-I30001	18.85	15.00	8.15	19.21	22.89	500 PCS
PD14-I30001	21.85	18.00	8.15	22.20	25.88	500 PCS
PD16-I30001	24.85	21.00	8.15	25.20	28.88	500 PCS
PD18-I30001	27.85	24.00	8.15	28.20	31.88	500 PCS
PD20-I30001	30.85	27.00	8.15	31.22	34.87	500 PCS
PD22-I30001	33.85	30.00	8.15	34.22	37.87	250 PCS
PD24-I30001	36.85	33.00	8.15	37.22	40.87	250 PCS

- 產品顏色(Product Color):
參考列表(Refer to description)
- 配合端子(Mates with terminal):
I30001PS系列 Series
- 配合塑膠(Mates with housing):
PD#-I30002
- 基板厚度(The thickness of the substrate): 1.6mm
- 包裝數量(Standard packing):
參考列表(Refer to description)

6. 此產品符合RoHS+無鹵要求
(The product conform to the RoHS and Halogen - Free directive)

品名(Part No.)	顏色(Color)
PD#-I30001-W	白色(White)
PD#-I30001	黑色(Black)



威力盛精工股份有限公司

WST WELI SHENG INDUSTRIAL CO., LTD.

PAGE : 1 OF 2

UL NO: E 149293	CSA NO:	TUV NO:	名稱(Name): 產品規格(Product specifications)	核發單位 (Issued by)	制定單位 (Instituted by)
			編號(Part No.): PD#-I30001系列 Series	技術部 2020-09-26 核發	開發課 2020-09-26 制定
			材質(Material): 尼龍[PA66 UL94 V-0]	單位(Unit):mm	比例(Scale):Free
			核准 (Approved by)	審查 (Confirmed by)	制定 (Drawn by)
正式發行(Official release)	1	24-Sep-20	甘牡丹	甘牡丹	甘牡丹
記號 (Sign)	變更內容 (Change description)	版次 (Edition)	制修訂日期 (Drawn date)	第三角法 (Projection):	一般公差 (General tolerance): ±0.3

產品成品圖
(Product drawing)

(3.0mm Pitch Series)
(Housing)

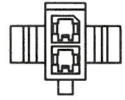

PD2

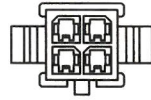

PD4

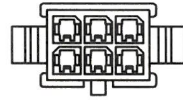

PD6

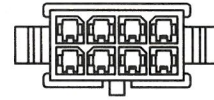

PD8

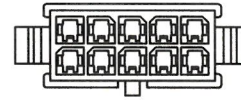

PD10

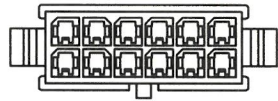

PD12

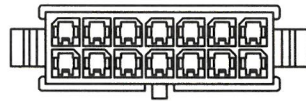

PD14

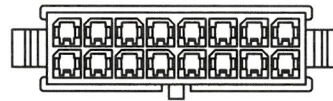

PD16

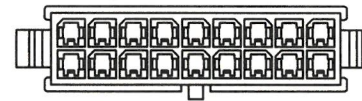

PD18

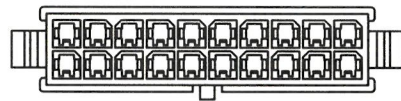

PD20

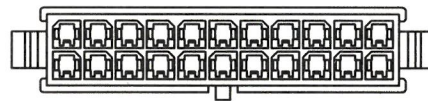

PD22

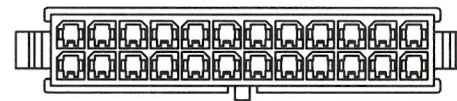

PD24



PAGE : 2 OF 2

威力盛精工股份有限公司
WST WELI SHENG INDUSTRIAL CO., LTD.

UL NO: 149293	CSA NO:	TUV NO:	名稱(Name): 產品規格(Product specifications)			核發單位 (Issued by)	制定單位 (Instituted by)
			編號(Part No.): PD#-I30001系列 Series			技術部 2020-09-26	開發課 2020-09-26
			材質(Material): 尼龍[PA66 UL94 V-0]			核發	制定
			核准 (Approved by)	審查 (Confirmed by)	制定 (Drawn by)	單位(Unit):mm	比例(Scale):Free
	正式發行(Official release)	1	24-Sep-20			甘牡丹	第三角法 (Projection):
記號 (Sign)	變更內容 (Change description)	版次 (Edition)	制修訂日期 (Drawn date)				一般公差 (General tolerance): ±0.3

