

Products with diode inside  are discontinued in 2014.

Panasonic
ideas for life

Automotive relay with ISO terminal arrangement

CB RELAYS



 Products to be discontinued.

FEATURES

1. This relay has an ISO (International Organization for Standardization) terminal arrangement.

Terminals are all solder plated.

*35 A type: Terminal is the plug-in type (no plating).

2. Relay is compact and high capacity (40 A).

Compact form factor realized with space saving 22 × 26 mm .866 × 1.024 inch small base area thanks to integrated bobbin and base construction. Features high switching capacity of 40 A

3. Features high thermal resistance of 125°C 257°F (heat resistant type).

Heat resistant type is available that can withstand use near engines. (40 A switching capacity)

4. Sealed type available for resisting adverse environments.

5. Protective element type is also available.

6. For only plug-in types, types with nominal switching capacities of 35 A (12 V) and 15 A (24 V) are available.

TYPICAL APPLICATIONS

1. Automobiles

Headlights, Cell motors, Air conditioners, ABS, EPS, etc.

2. Construction equipment

3. Agricultural equipment, Conveyor, etc.

ORDERING INFORMATION

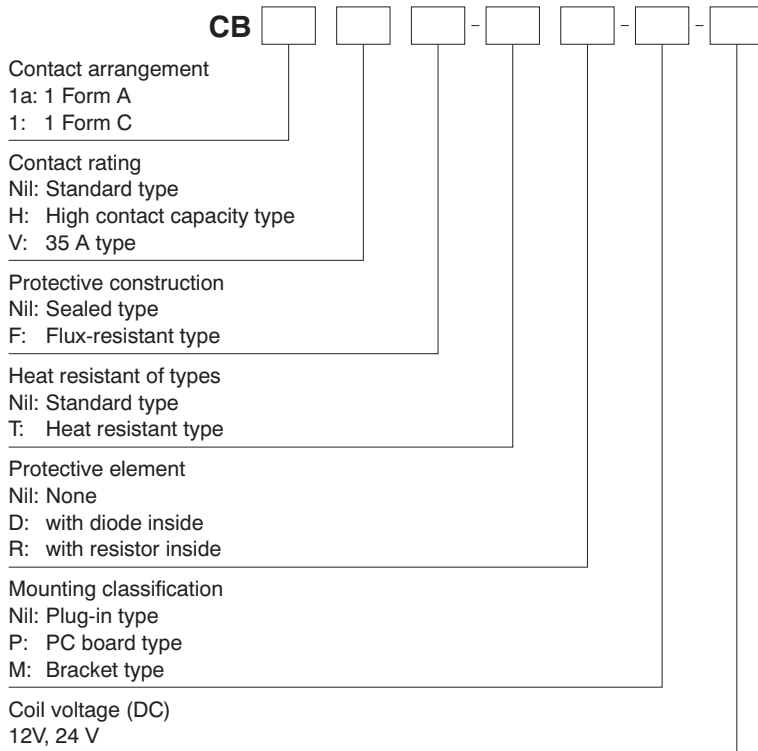

 D: with diode inside

TYPES

1. Standard type

Contact arrangement	Mounting classification	Nominal coil voltage	Sealed type	Flux-resistant type
			Part No.	Part No.
1 Form A	PC board type	12V DC	CB1a-P-12V	CB1aF-P-12V
		24V DC	CB1a-P-24V	CB1aF-P-24V
	Plug-in type	12V DC	CB1a-12V	CB1aF-12V
		24V DC	CB1a-24V	CB1aF-24V
	Bracket type	12V DC	CB1a-M-12V	CB1aF-M-12V
		24V DC	CB1a-M-24V	CB1aF-M-24V
1 Form C	PC board type	12V DC	CB1-P-12V	CB1F-P-12V
		24V DC	CB1-P-24V	CB1F-P-24V
	Plug-in type	12V DC	CB1-12V	CB1F-12V
		24V DC	CB1-24V	CB1F-24V
	Bracket type	12V DC	CB1-M-12V	CB1F-M-12V
		24V DC	CB1-M-24V	CB1F-M-24V
High contact capacity (1 Form A)	PC board type*	12V DC	CB1aH-P-12V	CB1aHF-P-12V
		24V DC	CB1aH-P-24V	CB1aHF-P-24V
	Plug-in type	12V DC	CB1aH-12V	CB1aHF-12V
		24V DC	CB1aH-24V	CB1aHF-24V
	Bracket type	12V DC	CB1aH-M-12V	CB1aHF-M-12V
		24V DC	CB1aH-M-24V	CB1aHF-M-24V

Packing quantity; Carton: 50 pcs. Case: 200 pcs.

Notes: 1. Please use "CB***R**" to order built-in resistor type and "CB***D**" to order  built-in diode type. (Asterisks "*" should be filled in from parts table.)

2. *Regarding solder, this product is not MIL (Military Standard) compliant. Please evaluate solder mounting by the actual equipment before using.

2. Heat resistant type











Contact arrangement	Mounting classification	Nominal coil voltage	Sealed type	Flux-resistant type
			Part No.	Part No.
1 Form A	PC board type	12V DC	CB1a-T-P-12V	CB1aF-T-P-12V
		24V DC	CB1a-T-P-24V	CB1aF-T-P-24V
	Plug-in type	12V DC	CB1a-T-12V	CB1aF-T-12V
		24V DC	CB1a-T-24V	CB1aF-T-24V
	Bracket type	12V DC	CB1a-T-M-12V	CB1aF-T-M-12V
		24V DC	CB1a-T-M-24V	CB1aF-T-M-24V
1 Form C	PC board type	12V DC	CB1-T-P-12V	CB1F-T-P-12V
		24V DC	CB1-T-P-24V	CB1F-T-P-24V
	Plug-in type	12V DC	CB1-T-12V	CB1F-T-12V
		24V DC	CB1-T-24V	CB1F-T-24V
	Bracket type	12V DC	CB1-T-M-12V	CB1F-T-M-12V
		24V DC	CB1-T-M-24V	CB1F-T-M-24V
High contact capacity (1 Form A)	PC board type*	12V DC	CB1aH-T-P-12V	CB1aHF-T-P-12V
		24V DC	CB1aH-T-P-24V	CB1aHF-T-P-24V
	Plug-in type	12V DC	CB1aH-T-12V	CB1aHF-T-12V
		24V DC	CB1aH-T-24V	CB1aHF-T-24V
	Bracket type	12V DC	CB1aH-T-M-12V	CB1aHF-T-M-12V
		24V DC	CB1aH-T-M-24V	CB1aHF-T-M-24V

Packing quantity; Carton: 50 pcs. Case: 200 pcs.

Notes: 1. Please use "CB***R**" to order built-in resistor type and "CB***D**" to order  built-in diode type. (Asterisks "*" should be filled in from parts table.)

2. *Regarding solder, this product is not MIL (Military Standard) compliant. Please evaluate solder mounting by the actual equipment before using.

3. 35 A type (*Terminals are all of the plug-in type.)

Contact arrangement	Nominal coil voltage	Sealed type	Flux-resistant type
		Part No.	Part No.
1 Form A	12V DC	CB1aV-12V	CB1aVF-12V
	24V DC	CB1aV-24V	CB1aVF-24V
1 Form C	12V DC	CB1V-12V	CB1VF-12V
	24V DC	CB1V-24V	CB1VF-24V
1 Form A with resistor inside	12V DC	CB1aV-R-12V	CB1aVF-R-12V
	24V DC	CB1aV-R-24V	CB1aVF-R-24V
1 Form C with resistor inside	12V DC	CB1V-R-12V	CB1VF-R-12V
	24V DC	CB1V-R-24V	CB1VF-R-24V
 1 Form A with diode inside	12V DC	 CB1aV-D-12V	 CB1aVF-D-12V
	24V DC	 CB1aV-D-24V	 CB1aVF-D-24V
 1 Form C with diode inside	12V DC	 CB1V-D-12V	 CB1VF-D-12V
	24V DC	 CB1V-D-24V	 CB1VF-D-24V

Packing quantity; Carton: 50 pcs. Case: 200 pcs.

RATING

1. Coil data

1) 1. No protective element

Contact arrangement	Nominal coil voltage	Pick-up voltage (Initial, at 20°C 68°F)	Drop-out voltage (Initial, at 20°C 68°F)	Nominal operating current (at 20°C 68°F)	Coil resistance (±10%) (at 20°C 68°F)	Nominal operating power (at 20°C 68°F)	Usable voltage range
1 Form A, 1 Form C	12V DC	3 to 7V DC	1.2 to 4.2V DC	117mA	103Ω	1.4W	10 to 16V DC
	24V DC	6 to 14V DC	2.4 to 8.4V DC	75mA	320Ω	1.8W	20 to 32V DC
High contact capacity (1 Form A)	12V DC	3 to 7V DC	1.2 to 4.2V DC	117mA	103Ω	1.4W (PC board type)	10 to 16V DC
				150mA	80Ω	1.8W	
	24V DC	6 to 14V DC	2.4 to 8.4V DC	58mA	411Ω	1.4W (PC board type)	20 to 32V DC
				75mA	320Ω	1.8W	

Note: Other pick-up voltage types are also available. Please contact us for details.

2) With resistor inside

Contact arrangement	Nominal coil voltage	Pick-up voltage (Initial, at 20°C 68°F)	Drop-out voltage (Initial, at 20°C 68°F)	Nominal operating current (at 20°C 68°F)	Combined resistance (±10%) (at 20°C 68°F)	Nominal operating power (at 20°C 68°F)	Usable voltage range
1 Form A, 1 Form C	12V DC	3 to 7V DC	1.2 to 4.2V DC	134mA	89.5Ω	1.6W	10 to 16V DC
	24V DC	6 to 14V DC	2.4 to 8.4V DC	84mA	287.2Ω	2.0W	20 to 32V DC

2. Specifications

1) Standard type (12 V coil voltage)

Characteristics	Item	Specifications	
Contact	Arrangement	1 Form A 1 Form C High contact capacity (1 Form A)	
	Contact resistance (Initial)	Typ2mΩ (By voltage drop 6 V DC 1 A)	
	Contact material	Ag alloy (Cadmium free)	
Rating	Nominal switching capacity (Initial)	40A 14V DC N.O.: 40A 14V DC N.C.: 30A 14V DC 70A 14V DC (at 20°C 68°F) 50A 14V DC (at 85°C 185°F)	
	Max. carrying current (Initial) (14V DC, at 85°C 185°F, continuous)	N.O.: 40A N.O.: 40A, N.C.: 30A N.O.: 40A	
	Nominal operating power	1.4W 1.4W 1.8W (1.4W: PC board type)	
	Min. switching capacity ^{*1}	1A 12V DC (12V DC), 1A 24V DC (24V DC)	
Electrical characteristics	Initial insulation resistance	Min. 20 MΩ (at 500 V DC)	
	Initial breakdown voltage	Between open contacts	500 Vrms for 1 min. (Detection current: 10mA)
		Between contacts and coil	500 Vrms for 1 min. (Detection current: 10mA)
	Operate time (at nominal voltage) (at 20°C 68°F)	Max. 15ms (at 20°C 68°F, excluding contact bounce time) (Initial)	
Release time (at nominal voltage) (at 20°C 68°F)	Max. 15ms (at 20°C 68°F, excluding contact bounce time, without diode) (Initial)		
Mechanical characteristics	Shock resistance	Functional	Min. 200 m/s ² {20G}
		Destructive	Min. 1,000 m/s ² {100G}
	Vibration resistance	Functional	10 Hz to 500 Hz, Min. 44.1m/s ² {4.5G}
		Destructive	10 Hz to 2,000 Hz, Min. 44.1m/s ² {4.5G} Time of vibration for each direction; X. Y. Z direction: 4 hours
Expected life	Electrical (at nominal switching capacity)	Flux-resistant type: Min. 10 ⁵ , Sealed type: Min. 5×10 ⁴ (Operating frequency: 2s ON, 2s OFF)	
	Mechanical	Min. 10 ⁶ (at 120 cpm)	
Conditions	Conditions for operation, transport and storage ^{*2}	Standard type; Ambient temp: -40 to +85°C -40 to +185°F, Humidity: 5 to 85% R.H. (Not freezing and condensing at low temperature)	
		Heat resistant type; Ambient temp: -40 to +125°C -40 to +257°F, Humidity: 5 to 85% R.H. (Not freezing and condensing at low temperature)	
	Max. operating speed	15 cpm (At nominal switching capacity)	
Unit weight		Approx. 33 g 1.16 oz	

Notes:

*1 This value can change due to the switching frequency, environmental conditions, and desired reliability level, therefore it is recommended to check this with the actual load.

*2 The upper operation ambient temperature limit is the maximum temperature that can satisfy the coil temperature rise value. Refer to "6. Usage, Storage and Transport Conditions" in AMBIENT ENVIRONMENT section in Relay Technical Information.

2) Standard type (24 V coil voltage)

Characteristics	Item	Specifications
Contact	Arrangement	1 Form A 1 Form C High contact capacity (1 Form A)
	Contact resistance (Initial)	Max. 15mΩ (By voltage drop 6 V DC 1 A)
	Contact material	Ag alloy (Cadmium free)
Rating	Nominal switching capacity (Initial)	20A 28V DC N.O.: 20A 28V DC N.C.: 10A 28V DC 20A 28V DC
	Max. carrying current (Initial) (28V DC, at 85°C 185°F, continuous)	20A N.O.: 20A, N.C.: 10A 20A
	Nominal operating power	1.8W 1.8W 1.8W, 1.4W (PC board type)

Note: All other specifications are the same as those of standard type (12 V coil voltage)

3) Heat resistant type (12 V and 24 V coil voltage)

Characteristics	Item	Specifications					
		12V			24V		
Contact	Arrangement	1 Form A	1 Form C	High contact capacity (1 Form A)	1 Form A	1 Form C	High contact capacity (1 Form A)
	Contact resistance (Initial)	Max. 15mΩ (By voltage drop 6 V DC 1 A)					
	Contact material	Ag alloy (Cadmium free)					
Rating	Nominal switching capacity (Initial)	40A 14V DC	N.O.: 40A 14V DC N.C.: 30A 14V DC	40A 14V DC	20A 28V DC	N.O.: 20A 28V DC N.C.: 10A 28V DC	20A 28V DC
	Max. carrying current (Initial) (at 85°C 185°F, continuous)*	50A 14V DC	N.O.: 50A 14V DC N.C.: 30A 14V DC	45A 14V DC 50A 14V DC	25A 28V DC	N.O.: 25A 28V DC N.C.: 10A 28V DC	25A 28V DC
	Nominal operating power	1.4W	1.4W	1.8W 1.4W (PC board type)	1.8W	1.8W	1.8W, 1.4W (PC board type)

Notes: 1. All other specifications are the same as those of standard type (12 V coil voltage)

2. *Current value in which carry current is possible when the coil temperature is 180°C 356°F

4) 35 A type (12 V coil voltage)

Characteristics	Item	Specifications	
		1 Form A	1 Form C
Contact	Arrangement	1 Form A	1 Form C
	Contact resistance (Initial)	Typ2mΩ (By voltage drop 6 V DC 1 A)	
	Contact material	Ag alloy (Cadmium free)	
Rating	Nominal switching capacity (Resistive load)	35A 14V DC	N.O.: 35A 14V DC, N.C.: 25A 14V DC
	Max. carrying current (Initial) (14V DC, at 85°C 185°F, continuous)	N.O.: 35A	N.O.: 35A, N.C.: 25A
	Nominal operating power	1.4W, 1.6W (with resistor inside)	
	Min. switching capacity (Reference value)*	1A 12V DC (12V DC), 1A 24V DC (24V DC)	
Electrical characteristics	Initial insulation resistance		Min. 20 MΩ (at 500 V DC)
	Initial breakdown voltage	Between open contacts	500 Vrms for 1 min. (Detection current: 10mA)
		Between contacts and coil	500 Vrms for 1 min. (Detection current: 10mA)
	Operate time (at nominal voltage)		Max. 15ms (excluding contact bounce time) (Initial)
	Release time (at nominal voltage)		Max. 15ms (excluding contact bounce time, without diode) (Initial)
Mechanical characteristics	Shock resistance	Functional	Min. 100 m/s ² {10G} (Half-wave pulse of sine wave: 11ms; detection: 10μs)
		Destructive	Min. 1,000 m/s ² {100G} (Half-wave pulse of sine wave: 6ms)
	Vibration resistance	Functional	10 Hz to 100 Hz, Min. 44.1m/s ² {4.5G} (Detection time: 10μs)
Destructive		10 Hz to 2,000 Hz, Min. 44.1m/s ² {4.5G} Time of vibration for each direction; X, Y, Z direction: 4 hours	
Expected life	Electrical (at nominal switching capacity)	Flux-resistant type: Min. 10 ⁵ ; Sealed type: Min. 5×10 ⁴ (Operating frequency: 2s ON, 2s OFF)	
	Mechanical	Min. 10 ⁶ (at 120 cpm)	
Conditions	Conditions for operation, transport and storage	Ambient temp: -40°C to +85°C -40°F to +185°F Humidity: 5% R.H. to 85% R.H. (Not freezing and condensing at low temperature)	
	Max. operating speed	15 cpm (At nominal switching capacity)	
Unit weight	Approx. 26 g .92 oz		

Note: * This value can change due to the switching frequency, environmental conditions, and desired reliability level, therefore it is recommended to check this with the actual load.

5) 35 A type (24 V coil voltage)

Characteristics	Item	Specifications	
		1 Form A	1 Form C
Contact	Arrangement	1 Form A	1 Form C
	Nominal switching capacity (Resistive load)	15A 28V DC	N.O.: 15A 28V DC, N.C.: 8A 28V DC
Rating	Max. carrying current (14V DC, at 85°C 185°F, continuous)	N.O.: 15A	N.O.: 15A, N.C.: 8A
	Nominal operating power	1.8W, 2.0W (with resistor inside)	

Note: All other specifications are the same as those of 35 A type (12 V coil voltage).

REFERENCE DATA

CB RELAYS (Standard type)

1. Allowable ambient temperature

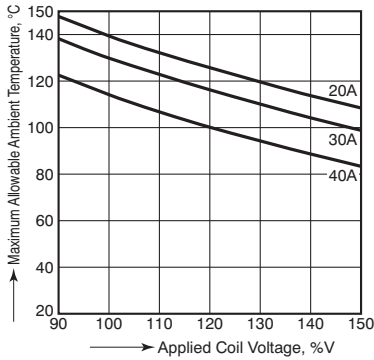

Assumption:

- Maximum mean coil temperature: 180°C
- Curves are based on 1.4W (Nominal power consumption of the unsuppressed coil at nominal voltage)

2. Max. switching capability (Resistive load) (Standard type)

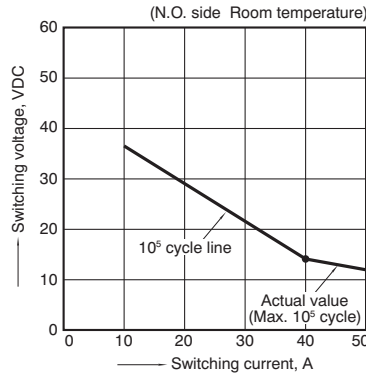

3. Ambient temperature and operating voltage range (Standard type)

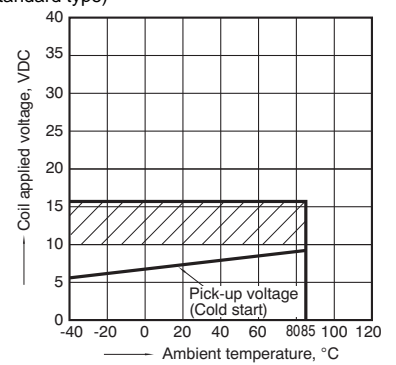

4. Distribution of pick-up and drop-out voltage

Sample: CB1-P-12V, 42pcs.

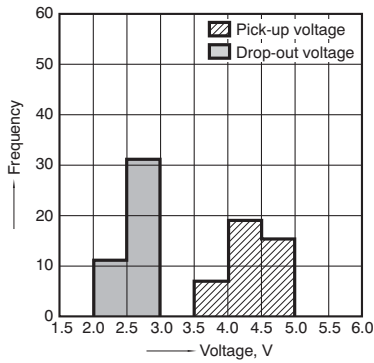

5. Distribution of operate and release time

Sample: CB1-P-24V, 42pcs.

* Without diode

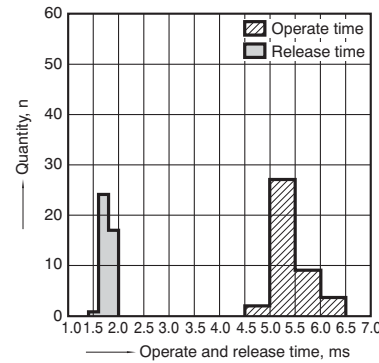

6-(1). Electrical life test (Motor free)

Sample: CB1F-12V, 5pcs.

Load: 25A 14V DC, motor free actual load

Switching frequency: (ON:OFF = 1s:9s)

Ambient temperature: Room temperature

Circuit

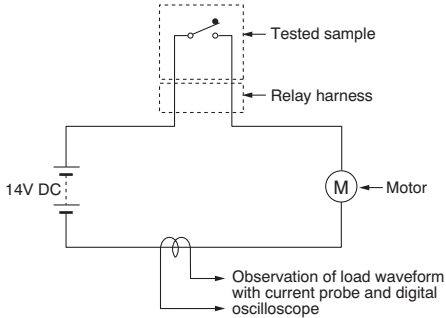

Load current waveform

Inrush current: 80A, Steady current: 25A

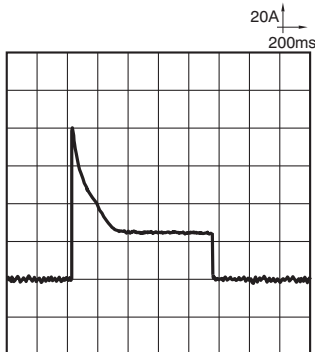

Change of pick-up and drop-out voltage

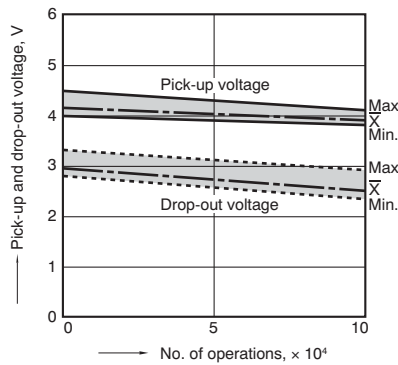

Change of contact resistance

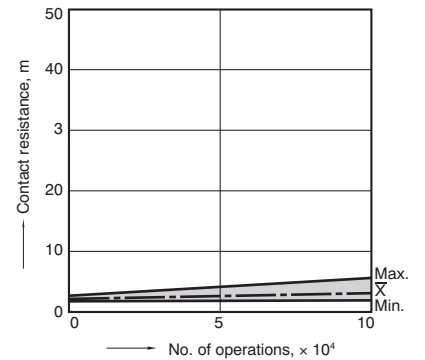

6-(2). Electrical life test (Lamp load)

Sample: CB1F-12V, 5pcs.
 Load: 45/65Wx5 parallel, 14V DC, halogen lamp actual load
 Switching frequency: (ON:OFF = 1s:8s)
 Ambient temperature: Room temperature
 Circuit

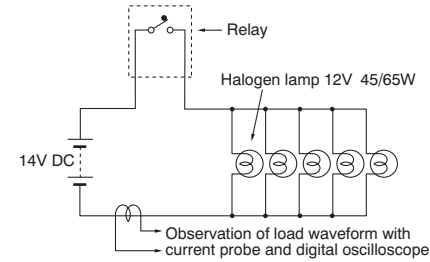

Change of pick-up and drop-out voltage

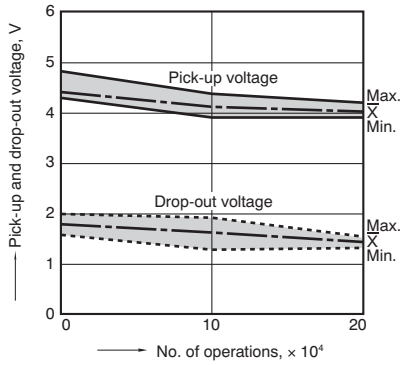

Change of contact resistance

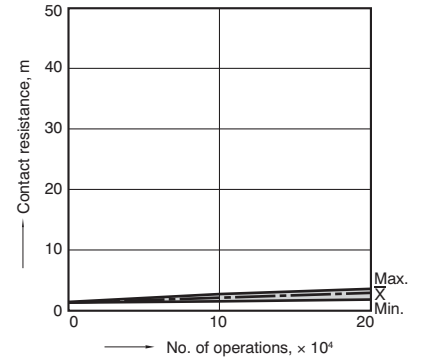

Load current waveform

Inrush current: 100A, Steady current: 20A

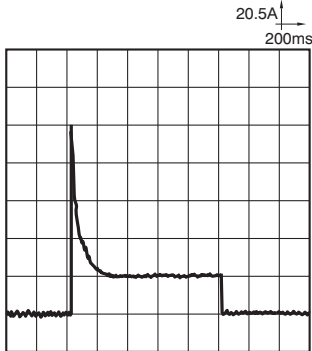

CB RELAYS (High contact capacity type)

1. Allowable ambient temperature

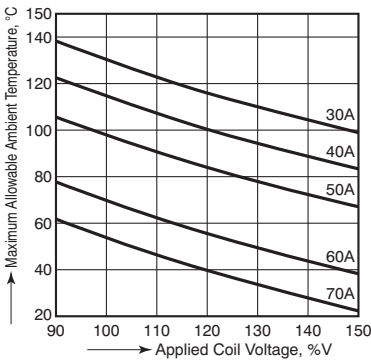

2. Max. switching capability (High contact capacity type)

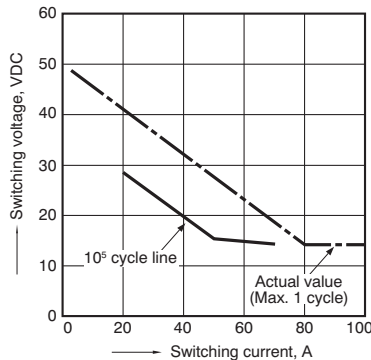

3. Ambient temperature and operating voltage range (High contact capacity type)

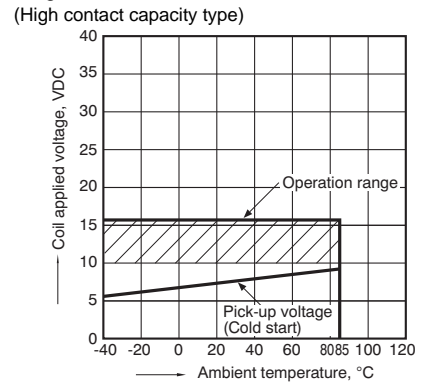

Assumption:

- Maximum mean coil temperature: 180°C
- Curves are based on 1.4W (Nominal power consumption of the unsuppressed coil at nominal voltage)

4. Distribution of pick-up and drop-out voltage

Sample: CB1aHF-12V, 53pcs.

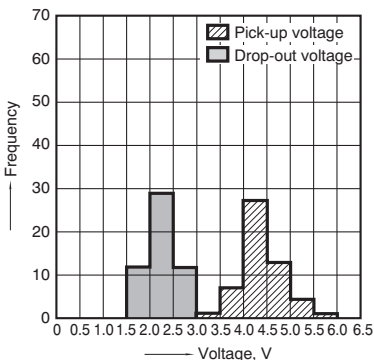

5. Distribution of operate and release time

Sample: CB1aHF-12V, 53pcs.

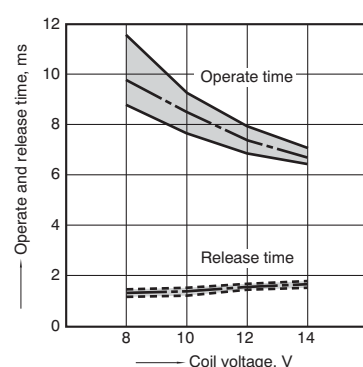

6. Contact resistance

Sample: CB1aHF-12V, 53pcs.
 (By voltage drop 6V DC 1A)

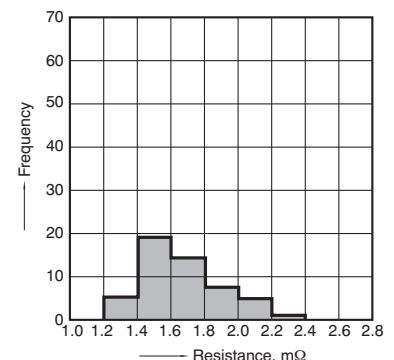

Products with diode inside  are discontinued in 2014.

7-(1). Electrical life test (Motor free)

Sample: CB1aH-12V, 3pcs.
 Load: Inrush current: 64A/Steady current: 35A
 Fan motor actual load (motor free) 12V DC
 Switching frequency: (ON:OFF = 3s:7s)
 Ambient temperature: Room temperature
 Circuit

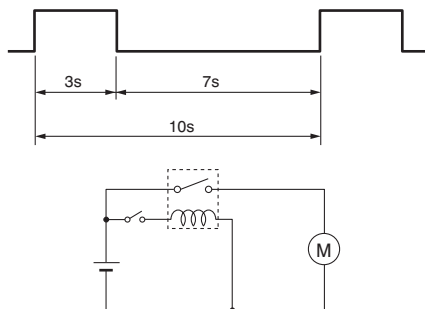

Load current waveform

Inrush current: 64A, Steady current: 35A

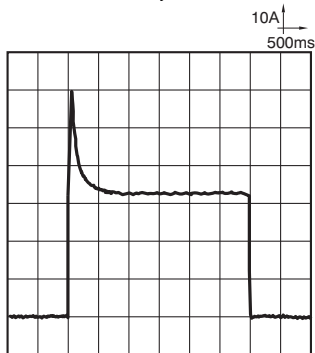

Change of pick-up and drop-out voltage

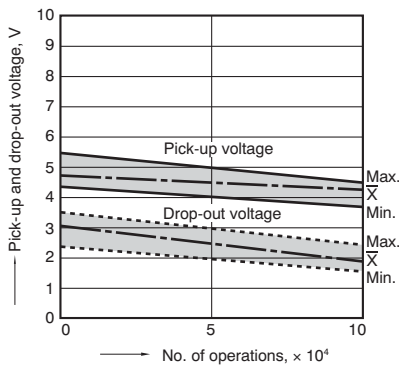

Change of contact resistance

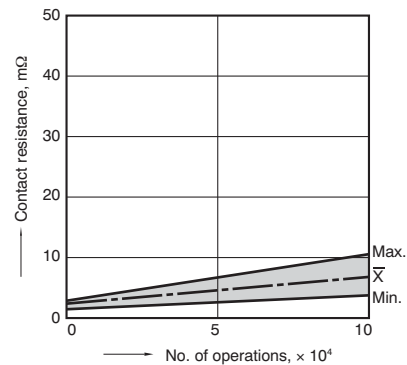

7-(2). Electrical life test (Motor lock)

Sample: CB1aH-12V, 5pcs.
 Load: 100A 14V DC
 Magnet clutch actual load (lock condition)
 Switching frequency: (ON:OFF = 1s:9s)
 Ambient temperature: Room temperature
 Circuit

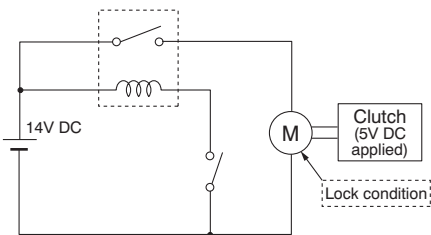

Load current waveform

100A 14V DC

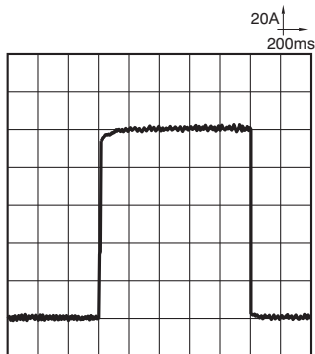

Change of pick-up and drop-out voltage

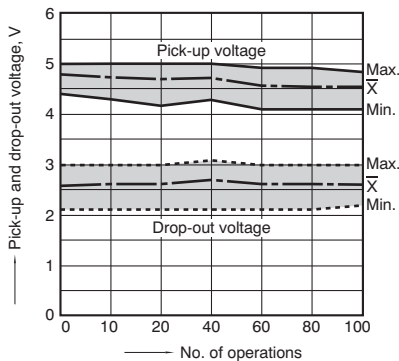

Change of contact resistance

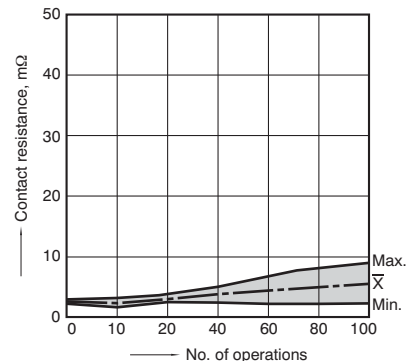

CB RELAY (35 A type)

1-(1). Distribution of pick-up and drop-out voltage

Sample: CB1aV-12V, 30pcs.

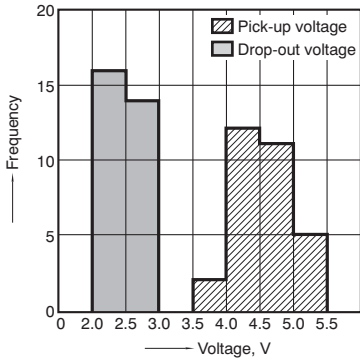

1-(2). Distribution of pick-up and drop-out voltage

Sample: CB1aV-24V, 30pcs.

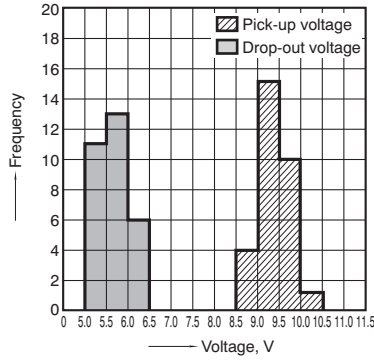

1-(3). Distribution of pick-up and drop-out voltage

Sample: CB1V-24V, 30pcs.

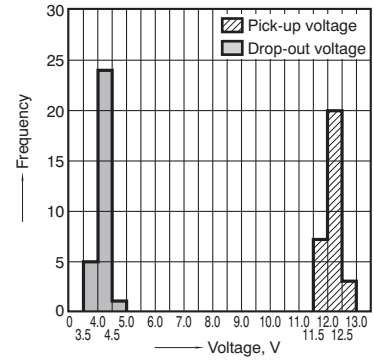

2-(1) Contact resistance

Sample: CB1aV-12V, 30pcs.
(By voltage drop 12 V DC 1A)

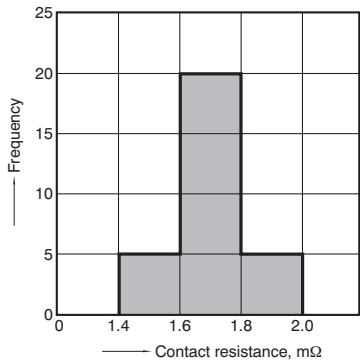

2-(2) Contact resistance

Sample: CB1aV-24V, 30pcs.
(By voltage drop 24 V DC 1A)

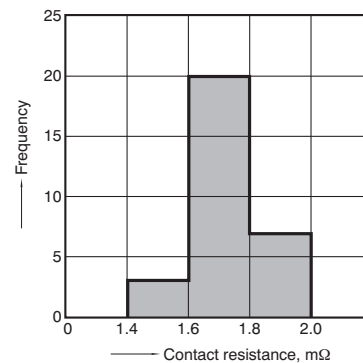

2-(3) Contact resistance

Sample: CB1V-24V, 30pcs.
(By voltage drop 24 V DC 1A)

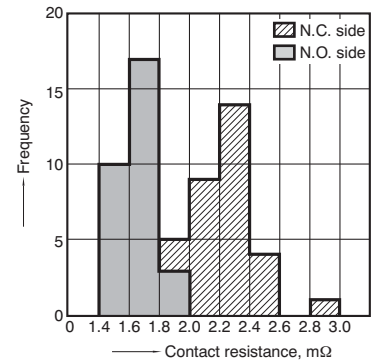

3. Electrical life test (Blower fan)

Sample: CB1aV-D-24V, 3pcs.
Load: Blower fan load 28 V DC
Inrush current: 30 A/Steady current: 10 A
Switching frequency: (ON:OFF = 3s:3s)
Switching cycle: 10⁵
Ambient temperature: 85°C
Coil protective element: Diode
Circuit

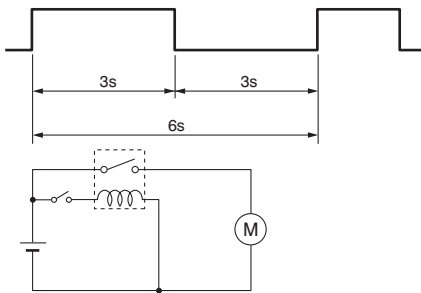

Load current waveform

Inrush current: 30 A, Steady current: 10 A

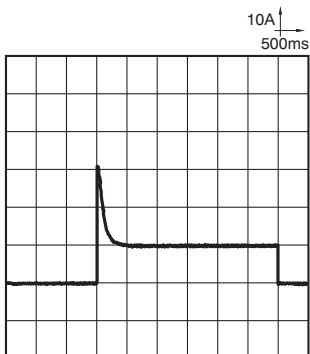

Change of pick-up and drop-out voltage

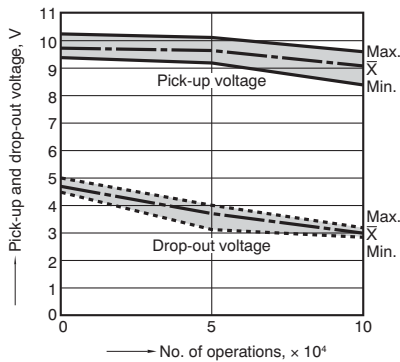

Change of contact resistance

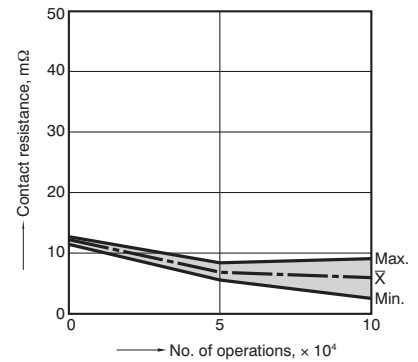

DIMENSIONS(mm inch)

Download [CAD Data](#) from our Web site.

1. PC board type

[CAD Data](#)



External dimensions

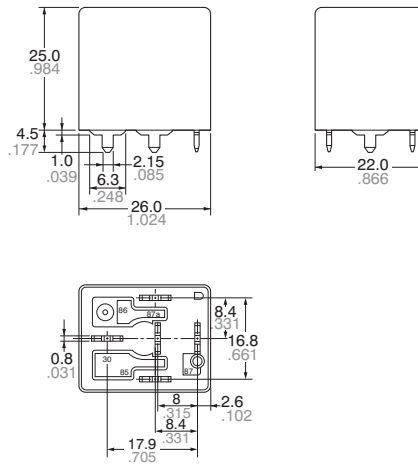

Schematic (Bottom view)

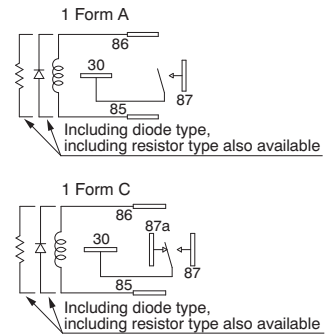

 diode type

PC board pattern (Bottom view)

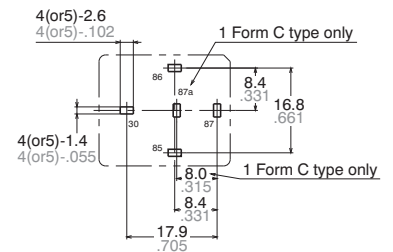

Dimension:
 Max. 1mm .039 inch: ±0.1 ±.004
 1 to 3mm .039 to .118 inch: ±0.2 ±.008
 Min. 3mm .118 inch: ±0.3 ±.012

General tolerance
 ±0.1 ±.004
 ±0.2 ±.008
 ±0.3 ±.012

2. Plug-in type * The dimensions are the same as those of 35A type.

[CAD Data](#)



External dimensions

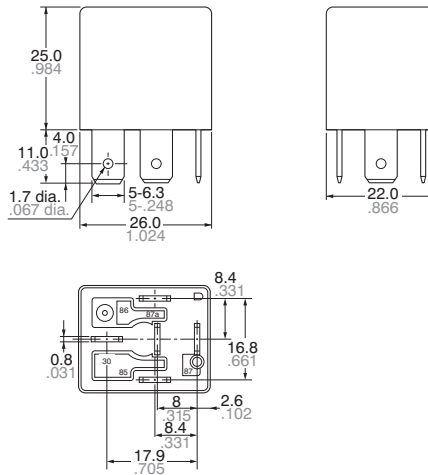

Schematic (Bottom view)

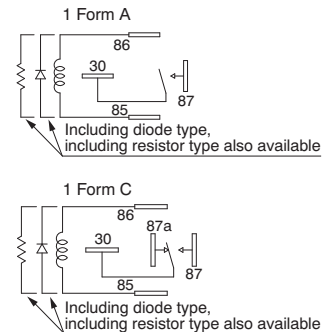

 diode type

Dimension:
 Max. 1mm .039 inch: ±0.1 ±.004
 1 to 3mm .039 to .118 inch: ±0.2 ±.008
 Min. 3mm .118 inch: ±0.3 ±.012

General tolerance
 ±0.1 ±.004
 ±0.2 ±.008
 ±0.3 ±.012

3. Bracket type

[CAD Data](#)



External dimensions

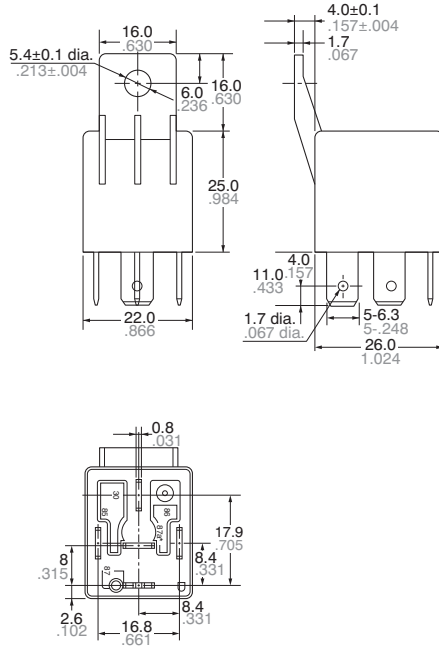

Schematic (Bottom view)

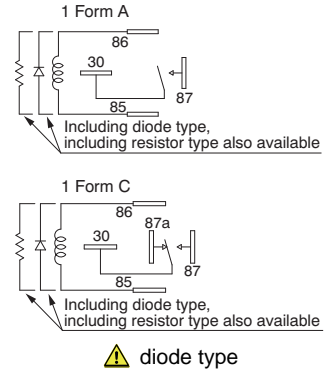

 diode type

Dimension:	General tolerance
Max. 1mm .039 inch:	±0.1 ±.004
1 to 3mm .039 to .118 inch:	±0.2 ±.008
Min. 3mm .118 inch:	±0.3 ±.012

4. High contact capacity (1 Form A) (Plug-in type)

[CAD Data](#)



External dimensions

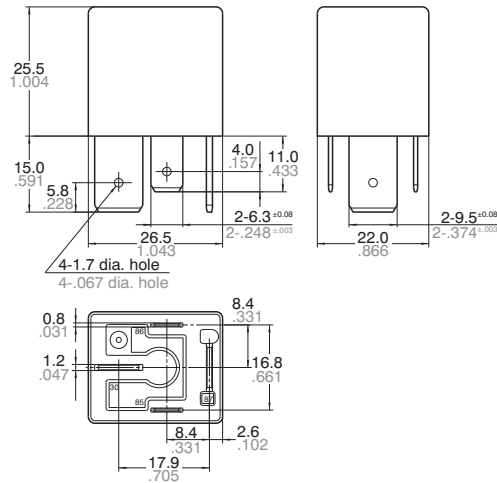

Schematic (Bottom view)

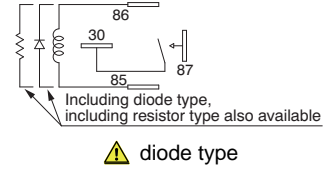

 diode type

Dimension:	General tolerance
Max. 1mm .039 inch:	±0.1 ±.004
1 to 3mm .039 to .118 inch:	±0.2 ±.008
Min. 3mm .118 inch:	±0.3 ±.012

Products with diode inside  are discontinued in 2014.

5. High contact capacity (1 Form A) (PC board type)

[CAD Data](#)



External dimensions

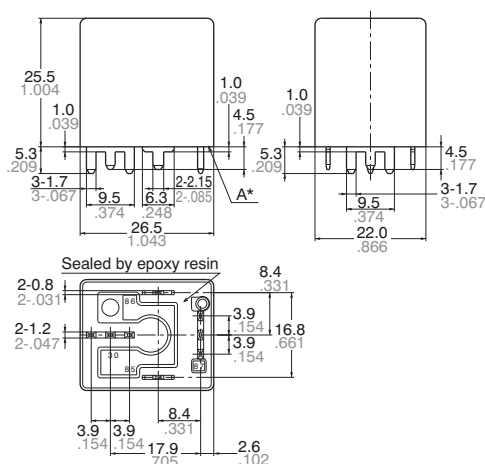

Schematic (Bottom view)

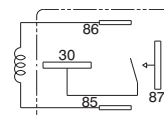

 diode type

PC board pattern (Bottom view)

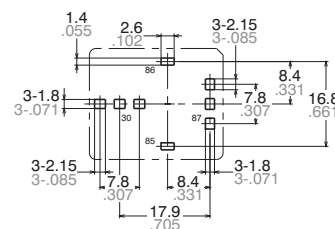

* Intervals between terminals is measured at A surface level.

Dimension:	General tolerance
Max. 1mm .039 inch:	±0.1 ±.004
1 to 3mm .039 to .118 inch:	±0.2 ±.008
Min. 3mm .118 inch:	±0.3 ±.012

Cautions regarding the protection element

1. Part numbers without protection elements

1) 12 V models

When connecting a coil surge protection circuit to these relays, we recommend a zener diode with a zener voltage of 24 V or higher, or a resistor (680Ω to 1,000Ω). When a diode is connected to the coil in parallel, the release time will slow down and working life may shorten. Before use, please check the circuit and verify that the diode is not connected in parallel to the coil drive circuit.

2) 24 V models

When connecting a coil surge protection circuit to these relays, we recommend a zener diode with a zener voltage of 48 V or higher, or a resistor (2,800Ω to 4,700Ω).

When a diode is connected to the coil in parallel, the release time will slow down and working life may shorten. Before use, please check the circuit and verify that the diode is not connected in parallel to the coil drive circuit.

 2. Part numbers with diodes

These relays use a diode in the coil surge protection element. Therefore, the release time is slower and the working life might be shorter compared to part numbers without protection elements and part numbers with resistors. Be sure to use only after evaluating under actual load conditions.

3. Part numbers with resistors

This part number employs a resistor in the coil surge protection circuit; therefore, an external surge protection element is not required. In particular, when a diode is connected in parallel with a coil, the release time becomes slower which could adversely affect working life. Please check the circuit and make sure that a diode is not connected in parallel with the coil drive circuit.

For Cautions for Use, see [Relay Technical Information](#).